

Photomicrosensor

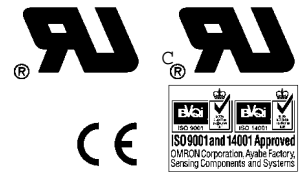

EE-SX770(A)/870(A)

Compact, Thin Model Ensures Ease of Use

- Compact model with a sensing slot identical in size to the previous sensing slot
- Allows M3-screw mounting
- Twelve models with different shapes (i.e., standard, L-shaped, and T-shaped models) are available.
- Approved by UL and EMC standards. Bears CE markings.
- Each model equipped with a retractable cord.
- Compact, thin, and allows high-density mounting
- Indicators are visible from both sides.
- Easy-to-see workpiece insertion mark
- Allows fine-tuning of sensing position.



Ordering Information

Appearance	Sensing method	Sensing distance	Output configuration	Model (see note)
Standard 	Through-beam (slot)	5 mm (slot width)	Dark ON	EE-SX770(A)
L-shaped 			Light ON	EE-SX870(A)
			Dark ON	EE-SX771(A)
T-shaped 			Light ON	EE-SX871(A)
			Dark ON	EE-SX772(A)

Note: The operation indicator of a model will turn ON when the light is interrupted if its model number ends with the suffix code (A).

Application Examples

Detection of Lead Frame Case Position

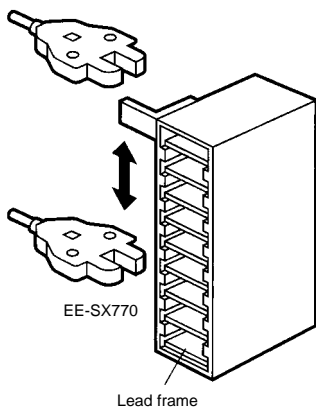

Detection of the Number of Valve Opening and Closing Operations

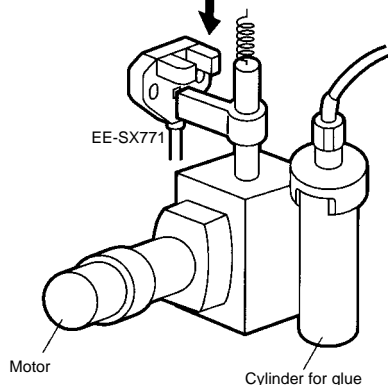

End Detection of Chip Part Cases

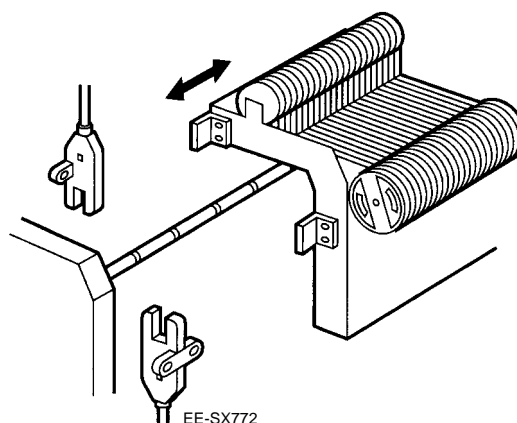

Specifications

■ Ratings/Characteristics

Item	Through-beam models(slot)
	EE-SX770(A), EE-SX771(A), EE-SX772(A), EE-SX870(A), EE-SX871(A), EE-SX872(A)
Sensing distance	5 mm (slot width)
Standard sensing object	Opaque: 2 x 0.8 mm min
Differential travel	0.025 mm
Light source (peak light wavelength)	GaAs infrared LED (940 nm)
Operation indicator	Red LED is ON with incident
Supply voltage	5 to 24 VDC \pm 10%, ripple (p-p): 10% max.
Current consumption	35 mA max.
Control output	NPN open collector, 5 to 24 VDC with a load current of 100 mA max. Residual voltage of 0.8 V max. with a load current of 100 mA and 0.4 V max. with a load current of 40 mA.
Protective circuit (see note 1)	Overcurrent protection (built-in circuit)
Response frequency (see note 2)	1 kHz
Ambient illuminance	Sensing surface: 1,000 lx max. with fluorescent light
Ambient temperature	Operating: -25°C to 55°C Storage: -30°C to 80°C
Ambient humidity	Operating: 5% to 85% Storage: 5% to 95%
Vibration resistance	Destruction: 20 to 2,000 Hz, 1.5-mm double amplitude for 2 hours each in X, Y, and Z directions
Shock resistance	Destruction: 500 m/s ² (50G), three times each in X, Y, and Z directions
Degree of protection	IEC60529 IP60
Connection method (standard length)	Pre-wired: 2 m
Casing material	PBT (polybutylene terephthalate)

- Note:**
- Operates when the load current exceeds the rated value of 100 mA to inhibit a current flow exceeding 120 mA.
 - The response frequency is a value obtained when the EE-SX detects a rotating disc with holes in it as shown to the right.

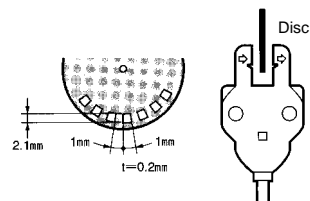

Engineering Data

Sensing Position (EE-SX77□)

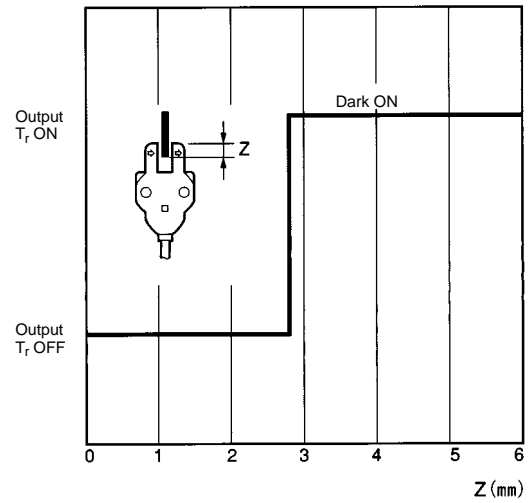
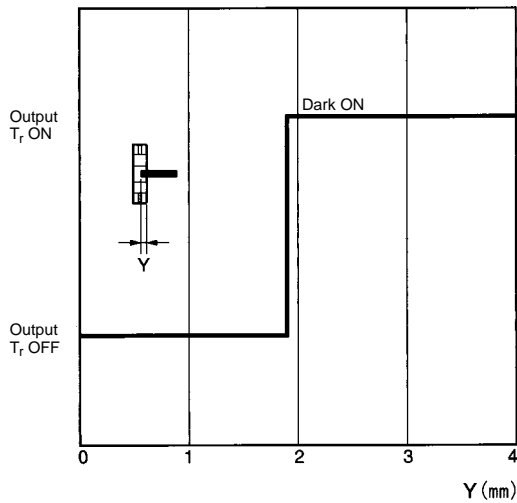

Operation

Output Circuits

Item	NPN output	
Model (see note)	EE-SX770(A) EE-SX771(A) EE-SX772(A)	EE-SX870(A) EE-SX871(A) EE-SX872(A)
Operating status of output transistor	Dark ON	Light ON
Timing charts		
Output circuit		

Note: The operation indicator of a model will turn ON when the light is interrupted if its model number ends with the suffix code (A).

T-shaped Models

EE-SX772(A)
EE-SX872(A)

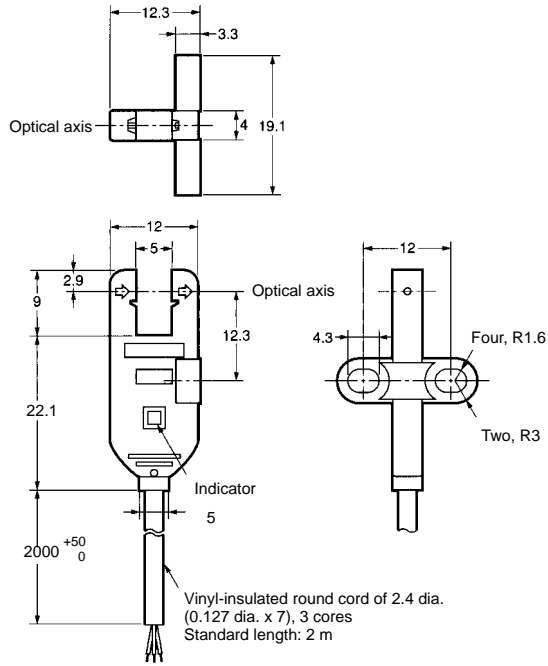
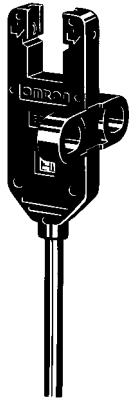

Precautions

Do not use the EE-SX at voltage exceeding the rated voltage range, otherwise the EE-SX may be damaged.

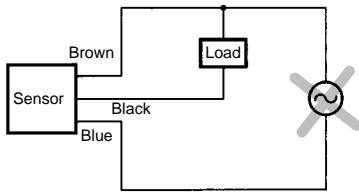

Do not make mistakes in wiring, such as mistakes in polarity, otherwise the EE-SX may be damaged.

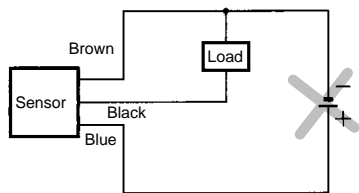

Do not short-circuit the load (i.e., do not connect a power supply directly to the Sensor) as shown below, otherwise the EE-SX may be damaged.

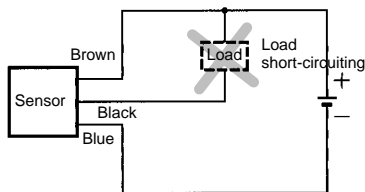

⚠ Caution

Mounting

The EE-SX is a Sensor to be built into equipment. Therefore, no special protective measures have been taken to protect the EE-SX from external light disturbance. Make sure that the EE-SX is not affected by incandescent lamps or other light sources that may cause external light disturbance, otherwise the EE-SX may malfunction.

Be sure to mount the Sensor securely to flat plates. The characteristics of the Through-beam Sensor change if the slot is deformed.

Use M3.0 screws when mounting the EE-SX. Be sure to use spring washers with the screws so that the screws will not loosen. The tightening torque applied to each screw must be no more than 0.59 N • m (6 kgf • cm).

Make sure that nothing will come into contact with the sensing element of the Sensor. If the sensing element has scratch damage, the characteristics of the Sensor will decrease.

Make sure that the EE-SX is securely mounted and not loosened by vibration or shock.

Wiring

Countermeasures Against Surge

If the power supply has surge voltage, connect a Zener diode with standing 30 to 35 V or 0.1 to 1- μ F capacitor in parallel to the power supply to absorb the surge voltage.

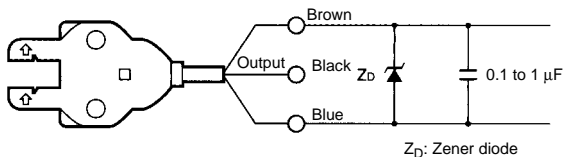

If the load is a relay or other small inductive load, connect the load to the EE-SX as shown below. Be sure to connect a diode for counter-voltage absorption.

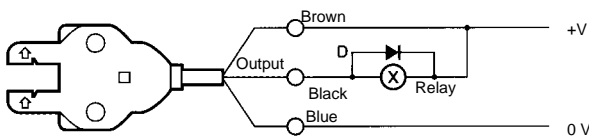

Do not wire power lines or high-tension lines alongside the lines of the EE-SX in the same conduit, otherwise the EE-SX may be damaged or malfunction due to induction. Be sure to wire the lines of the EE-SX separately from power lines or high-tension lines or lay them in an exclusive, shielded conduit.

Voltage Output

A Sensor with open collector output can be connected to a device with voltage-input specifications by connecting a resistor between the power supply and output terminals as shown in the following circuit diagram. The resistance of the resistor is normally 4.7 k Ω and must withstand a power of 0.5 W at 24 V and 0.25 W at 12 V.

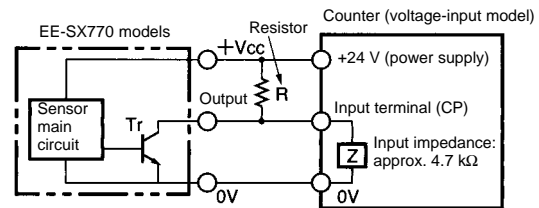

EE-SX770 Models with a 4.7-k Ω Resistor

High level:

$$\text{Input voltage (}V_H\text{)} = \frac{Z}{R+Z} V_{CC} = \frac{4.7 \text{ k}}{4.7 \text{ k} + 4.7 \text{ k}} \times 24 \text{ V} = 12 \text{ V}$$

Low level:

$$\text{Input voltage (}V_L\text{)} \leq 0.4 \text{ V}$$

$$\text{Load current (}I_C\text{)} = \frac{V_{CC}}{R} = \frac{24 \text{ V}}{R} = 5.1 \text{ mA} \leq 100 \text{ mA}$$

Note: Refer to the ratings of the Sensor for the relationship between the residual voltage and load current.

Others

Do not wire the EE-SX while power is applied, otherwise the EE-SX may be damaged.

Do not install the EE-SX in the following locations, otherwise the EE-SX may be damaged or malfunction.

Locations with excessive dust

Locations with corrosive gas

Locations where water, oil, or chemical is directly sprayed

Outdoors or locations exposed to direct sunlight

Make sure that the operating ambient temperature is within the rated range.

The Sensor may be soluble in organic solvent, acid, and alkaline, aromatic hydrocarbon, and chlorinated aliphatic hydrocarbon solvents. The characteristics of the Sensor may decrease as a result. Therefore, make sure that the Sensor is free from these solutions.

■ Notice

Photomicrosensors and Connectors have been certified as products that conform to the following UL Standard.

Certified Date: February 9, 1998
Certified Models: All OMRON EE-S Photomicrosensors and all OMRON EE Photomicrosensor Connectors for the EE-S Sensors
File No.: E41515
Standard Name: UL508: industrial control devices
Certification Method: UL Recognition (recognition certification for products used in the U.S.A.) and Canadian UL Recognition (recognition certification for products used in Canada)
Applicable Lot No.: 928 and after (products manufactured on and after February 9, 1998)

The following Photomicrosensors have been certified as products conforming to the EMC Directives (CE marking).

CE Marking Date: April 1, 1998
Applicable Models: All EE-SX47/67 (A) models
EE-SY671/672
EE-SPW311/411
EE-SPY311/312
EE-SPY301/302
EE-SPY401/402
EE-SPY411/412
EE-SPX302/304/306-W2A
EE-SPX402/404/406-W2A
EE-SPX303/403
EE-SPX301/401

ALL DIMENSIONS SHOWN ARE IN MILLIMETERS.

To convert millimeters into inches, multiply by 0.03937. To convert grams into ounces, multiply by 0.03527.

Cat. No. E276-E1-1 **In the interest of product improvement, specifications are subject to change without notice.**

OMRON Corporation

Industrial Sensors Division
Sensing Devices and Components Division H.Q.
28th Fl., Crystal Tower Bldg.,
1-2-27, Shiromi, Chuo-ku,
Osaka 540-6028 Japan
Phone: (81)6-949-6012 Fax: (81)6-949-6021

Printed in Japan
0498-2M (0498) Ⓐ