



High-performance Temperature Meter Accepts Temperature/Analog Inputs

- Multirange capability: a single processor connects to 14 different types of sensor and current/voltage.
- Easily programmable through the front panel or via RS-232C, RS-485, or RS-422.
- Programming with easy setup and calibration.
- A wide range of Output Boards, including communications and linear boards.
- High accuracy: 100-ms sampling for analog input
- High visibility: 14.2-mm-high red LED display
- °C/°F display selection.
- NEMA4X/IP66 front panel.
- Conforms to EMC standards, EN61010-1 (IEC61010-1).
- UL/CSA approved.



Ordering Information

■ Base Unit

Model	Supply voltage	
	100 to 240 VAC	12 to 24 VDC
Basic Models These models provide a present value LED and front-panel control keys. Can be connected to any Output Board, or can be used for display only without an Output Board. 	K3NH-TA1A	K3NH-TA2A
Set Value LED Models These models provide a present value LED, set value LED, and front-panel control keys. Can be connected to Relay, Transistor, or Combination Output Boards. 	K3NH-TA1C	K3NH-TA2C

■ Ranges

Platinum Resistance Thermometer

Input		JPt100	Pt100
Range	°C	-199.9 to 650.0	-199.9 to 650.0
	°F	-199.9 to 999.9	-199.9 to 999.9
Parameter		JPt	Pt

Thermocouple

Input (see note)		K1	K2	J1	J2	T	E	L1	L2	U	N	R	S	B	W	PLII
Range	°C	-200 to 1,300	0.0 to 500.0	-100 to 850	0.0 to 400.0	-199.9 to 400.0	0 to 600	-100 to 850	0.0 to 400.0	-199.9 to 400.0	-200 to 1,300	0 to 1,700	0 to 1,700	100 to 1,800	0 to 2,300	0 to 1,300
	°F	-300 to 2,300	0.0 to 900.0	-100 to 1,500	0.0 to 750.0	-199.9 to 700.0	0 to 1,100	-100 to 1,500	0.0 to 750.0	-199.9 to 700.0	-300 to 2,300	0 to 3,000	0 to 3,000	300 to 3,200	0 to 4,100	0 to 2,300
Parameter		P1CR	P2CR	J1CC	J2CC	TCC	ECC	L1CC	L2CC	UCC	n	r Pr	s Pr	b Pr	W26	PL 2

Note: Thermocouple W is W/Re5-26 (tungsten rhenium 5, tungsten rhenium 26).

Current/Voltage

Input	Current input		Voltage input		
	4 to 20 mA	0 to 20 mA	1 to 5 V	0 to 5 V	0 to 10 V
Range	One of following ranges depending on results of scaling -1999 to 9999 -199.9 to 999.9 -19.99 to 99.99 -1.999 to 9.999				
Parameter	4020	0020	105	005	0010

■ Available Output Board Combinations

Output type	Output configuration	Output boards	Base units	
			Basic	Set Value LED Display
Relay contact	3 outputs: H, PASS, L (SPDT)	K31-C1	Yes	Yes
	5 outputs: HH, H, L, LL (SPST-NO), and PASS (SPDT)	K31-C2	Yes	Yes
	5 outputs: HH, H, L, LL (SPST-NC), and PASS (SPDT)	K31-C5	Yes	Yes
Transistor	5 outputs (NPN open collector)	K31-T1	Yes	Yes
	5 outputs (PNP open collector)	K31-T2	Yes	Yes
BCD (see note)	5-digit output (NPN open collector)	K31-B2	Yes	---
Linear	4 to 20 mA DC	K31-L1	Yes	---
	1 to 5 VDC	K31-L2	Yes	---
	1 mV/10 digits	K31-L3	Yes	---
	0 to 5 VDC	K31-L7	Yes	---
	0 to 10 VDC	K31-L8	Yes	---
Communication boards (see note)	RS-232C	K31-FLK1	Yes	---
	RS-485	K31-FLK2	Yes	---
	RS-422	K31-FLK3	Yes	---
Combination output and communication boards	BCD output + 5 transistor outputs (NPN open collector)	K31-B4	Yes	Yes
	4 to 20 mA + 5 transistor outputs (NPN open collector)	K31-L4	Yes	Yes
	1 to 5 V + 5 transistor outputs (NPN open collector)	K31-L5	Yes	Yes
	1 mV/10 digits + 5 transistor outputs (NPN open collector)	K31-L6	Yes	Yes
	0 to 5 VDC + 5 transistor outputs (NPN open collector)	K31-L9	Yes	Yes
	0 to 10 VDC + 5 transistor outputs (NPN open collector)	K31-L10	Yes	Yes
	RS-232C + 5 transistor outputs (NPN open collector)	K31-FLK4	Yes	Yes
	RS-485 + 5 transistor outputs (NPN open collector)	K31-FLK5	Yes	Yes
	RS-422 + 5 transistor outputs (NPN open collector)	K31-FLK6	Yes	Yes

Note: For details, refer to the *Communication Operation Manual*.

■ Model Number Legend

Base Units and Output Boards can be ordered individually or as sets. Refer to the *Available Output Board Combinations* table on page 2.

Base Units

K3NH -
 1 2 3 4

Output Boards

K31 -
 5 6 7 8

Base Units with Output Boards

K3NH - -
 1 2 3 4 5 6 7 8

1, 2. Input Sensors Codes

TA: Current series

3. Supply Voltage

1: 100 to 240 VAC

2: 12 to 24 VDC

4. Display

A: Basic Model

C: Set value LED display

5, 6, 7, 8. Output Type Codes

C1: 3 comparative relay contact outputs (H, PASS, L: SPDT)

C2: 5 comparative relay contact outputs (HH, H, L, LL: SPST-NO; PASS: SPDT)

C5: 5 comparative relay contact outputs (HH, H, L, LL: SPST-NC; PASS: SPDT)

T1: 5 comparative transistor outputs (NPN open collector)

T2: 5 comparative transistor outputs (PNP open collector)

B2: BCD output (NPN open collector) (see note)

B4: BCD output + 5 transistor outputs (NPN open collector)

L1: Linear output (4 to 20 mA) (see note)

L2: Linear output (1 to 5 VDC) (see note)

L3: Linear output (1 mV/10 digits) (see note)

L4: Linear output, 4 to 20 mA + 5 transistor outputs (NPN open collector)

L5: Linear output, 1 to 5 V + 5 transistor outputs (NPN open collector)

L6: Linear output, 1 mV/10 digits+ 5 transistor outputs (NPN open collector)

L7: Linear output, 0 to 5 VDC (see note)

L8: Linear output, 0 to 10 VDC (see note)

L9: Linear output, 0 to 5 VDC + 5 transistor outputs (NPN open collector)

L10: Linear output, 0 to 10 VDC + 5 transistor outputs (NPN open collector)

FLK1: Communication RS-232C (see note)

FLK2: Communication RS-485 (see note)

FLK3: Communication RS-422 (see note)

FLK4: RS-232C + 5 transistor outputs (NPN open collector)

FLK5: RS-485 + 5 transistor outputs (NPN open collector)

FLK6: RS-422 + 5 transistor outputs (NPN open collector)

Note: These output types are available on Basic Models only.

Specifications

■ Ratings

Supply voltage	100 to 240 VAC (50/60 Hz); 12 to 24 VDC
Operating voltage range	85% to 110% of supply voltage
Power consumption (see note)	15 VA max. (max. AC load with all indicators lit) 10 W max. (max. DC load with all indicators lit)
Insulation resistance	20 M Ω min. (at 500 VDC) between external terminal and case. Insulation provided between inputs, outputs, and power supply.
Dielectric withstand voltage	2,000 VAC for 1 min between external terminal and case. Insulation provided between inputs, outputs, and power supply.
Noise immunity	\pm 1,500 V on power supply terminals in normal or common mode \pm 1 μ s, 100 ns for square-wave noise with 1 ns
Vibration resistance	Malfunction: 10 to 55 Hz, 0.5-mm for 10 min each in X, Y, and Z directions Destruction: 10 to 55 Hz, 0.75-mm for 2 hrs each in X, Y, and Z directions
Shock resistance	Malfunction: 98 m/s ² (10G) for 3 times each in X, Y, and Z directions Destruction: 294 m/s ² (30G) for 3 times each in X, Y, and Z directions
Ambient temperature	Operating: -10°C to 55°C (with no icing) Storage: -20°C to 65°C (with no icing)
Ambient humidity	Operating: 25% to 85% (with no condensation)
Ambient atmosphere	Must be free of corrosive gas
EMC	Emission Enclosure: EN55011 Group 1 class A Emission AC Mains: EN55011 Group 1 class A Immunity ESD: EN61000-4-2: 4-kV contact discharge (level 2) 8-kV air discharge (level 3) Immunity-RF-interference: ENV50140: 10 V/m (amplitude modulated, 80 MHz to 1 GHz) (level 3) 10 V/m (pulse modulated, 900 MHz) Immunity Conducted Disturbance: ENV50141: 10 V (0.15 to 80 MHz) (level 3) Immunity Burst: EN61000-4-4: 2-kV power-line (level 3) 2-kV I/O signal-line (level 4)
Approved standards	UL508, CSA22.2; conforms to EN50081-2, EN50082-2, EN61010-1 (IEC61010-1); conforms to VDE106/part 100 (Finger Protection) when the terminal cover is mounted.
Weight	Approx. 400 g

Note: An Intelligent Signal Processor with DC supply voltage requires approximately 1 A DC as control power supply current the moment the Intelligent Signal Processor is turned on. Do not forget to take this into consideration when using several Intelligent Signal Processors. When the Intelligent Signal Processor is not in measuring operation (e.g., the Intelligent Signal Processor has been just turned on or is operating for startup compensation time), the display will read "00000" and all outputs will be OFF.

Input/Output Ratings

Relay Contact Output

(Incorporating a G6B Relay)

Item	Resistive load ($\cos\phi = 1$)	Inductive load ($\cos\phi = 0.4$, L/R = 7 ms)
Rated load	5 A at 250 VAC; 5 A at 30 VDC	1.5 A at 250 VAC, 1.5 A at 30 VDC
Rated carry current	5 A max. (at COM terminal)	
Max. contact voltage	380 VAC, 125 VDC	
Max. contact current	5 A max. (at COM terminal)	
Max. switching capacity	1,250 VA, 150 W	375 VA, 80 W
Min. permissible load (P level, reference value)	10 mA at 5 VDC	
Mechanical life	50,000,000 times min. (at a switching frequency of 18,000 times/hr)	
Electrical life (at an ambient temperature of 23°C)	100,000 times min. (at a rated load switching frequency of 1,800 times/hr)	

Transistor Output

Rated load voltage	24 VDC max.
Max. load current	50 mA
Leakage current	100 μ A max.

BCD Output

I/O signal name		Item	Rating
Inputs	REQUEST, HOLD, MAX, MIN, RESET	Input signal	No-voltage contact input
		Input current with no-voltage input	10 mA
		Signal level	ON voltage: 1.5 V max. OFF voltage: 3 V min.
Outputs	DATA, POLARITY, OVERFLOW, DATA VALID, RUN	Rated load voltage	12 to 24 VDC $+10\%/-15\%$
		Max. load current	10 mA
		Leakage current	100 μ A max.

Note: Logic method: negative logic

Linear Output

Item	4 to 20 mA	1 to 5 V	1 mV/10 digits (see note)
Resolution	4,096		
Output error	$\pm 0.5\%$ FS		$\pm 1.5\%$ FS
Permissible load resistance	600 Ω max.	500 Ω min.	1 K Ω min.

Note: For the 1 mV/10-digit output, the output voltage changes for every 40 to 50 increment in the display value.

■ Communications

Item		RS-232C, RS-422	RS-485
Transmission method		4-wire, half-duplex	2-wire, half-duplex
Synchronization method		Start-stop synchronization	
Baud rate		1,200/2,400/4,800/9,600/19,200/38,400 bps	
Transmission code		ASCII (7-bit)	
Communications	Write to K3NH	Comparative set value, scaling value, remote/local programming, reset control of maximum/minimum values, and other setting mode items excluding communications conditions.	
	Read from K3NH	Process value, comparative set value, maximum value, minimum value, model data, error code, and others	

For details, refer to *Communication Operation Manual*.

■ Characteristics

Indication accuracy (at 23±5°C) (see note)	Thermocouple: (±0.3% of indication value or ±1°C, whichever greater) ±1 digit max. Platinum resistance thermometer: (±0.2% of indication value or ±0.8°C, whichever greater) ±1 digit max. Analog input: ±0.2% FS ±1 digit max.
Input	Thermocouple: K, J, T, E, L, U, N, R, S, B, W, PLII Platinum resistance thermometer: JPt100, Pt100 Current input: 4 to 20 mA, 0 to 20 mA Voltage input: 1 to 5 V, 0 to 5 V, 0 to 10 V
Sampling period	Temperature input: 250 ms Analog input: 100 ms
Input shift	Two-point settings (upper limit and lower limit)
Max. displayed digits	5 digits (-19999 to 99999)
Display	7-segment LED
Polarity display	"-" is displayed automatically with a negative input signal.
Zero display	Leading zeros are not displayed.
HOLD function	Maximum hold (maximum data) Minimum hold (minimum data)
External controls	HOLD: (Process value held) RESET: (Maximum/Minimum data reset)
Comparative output hysteresis setting	Programmable with front-panel key inputs (1 to 9999).
Other functions	Variable linear output range (for models with linear outputs only) Remote/Local processing (available for communications output models only) Maximum/Minimum value data reset with front panel keys °C/°F display selection Averaging processing function (simple or moving average) Comparative output pattern selection Standby sequence Security Field calibration
Output configuration	Relay contact output (5 outputs) Transistor output (NPN and PNP open collector), BCD (NPN open collector) Parallel BCD (NPN open collector) + transistor output (NPN open collector) Linear output (4 to 20 mA, 1 to 5 V) + transistor output (NPN open collector) Communication functions (RS-232C, RS-485, RS-422) Communication functions (RS-232C, RS-485, RS-422) + transistor output (NPN open collector)
Delay in comparative outputs (transistor output)	500 ms max.
Enclosure rating	Front panel: NEMA4X for indoor use (equivalent to IP66) Rear case: IEC standard IP20 Terminals: IEC standard IP00
Memory protection	Non-volatile memory (EEPROM) (possible to rewrite 100,000 times)

Note: The indication accuracy of the K1, T, and N thermocouples at a temperature of -100°C or less is ±2°C ±1 digit maximum. The indication accuracy of the U, L1, and L2 thermocouples at any temperature is ±2°C ±1 digit maximum.
The indication accuracy of the B thermocouple at a temperature of 400°C or less is unrestricted.
The indication accuracy of the R and S thermocouples at a temperature of 200°C or less is ±3°C ±1 digit maximum.
The indication accuracy of the W thermocouple at any temperature is (±0.3% of the indicated value or ±3°C, whichever is greater) ±1 digit maximum.
The indication accuracy of the PLII thermocouple at any temperature is (±0.3% or ±2°C, whichever is greater) ±1 digit maximum.

Nomenclature

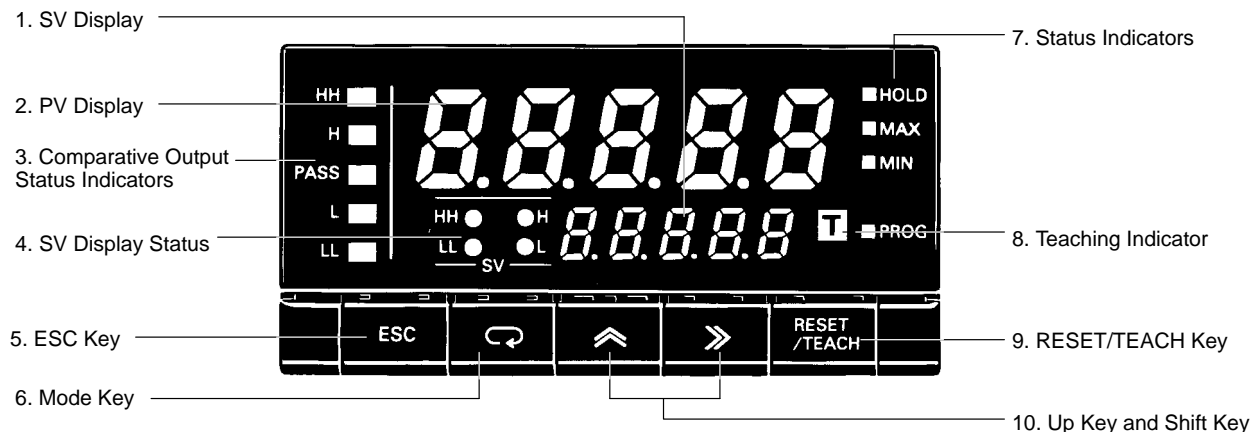

Name	Functions
1. SV display	Displays the set value or parameter. Available for Set Value LED Models only.
2. PV display	Displays the process value in addition to the max/min value or parameter.
3. Comparative output status indicators	Displays the status of comparative output.
4. SV display status	Indicates which comparative set value is currently on the SV display.
5. ESC Key	Used to return to the RUN mode from the Setting Protect, or Maintenance mode. The process value, maximum value, or minimum value to be displayed can be selected.
6. Mode Key	Used to enter the Setting mode. Used to allow the PV display to indicate set values sequentially. Available for Basic Models only. Used to indicate set values sequentially on the SV display. Available for Set Value LED Models only.
7. Status indicators	HOLD: Lit when HOLD input is ON. MAX: Lit when the maximum value is indicated on the PV display. MIN: Lit when the minimum value is indicated on the PV display. PROG: Lit or flashes while parameters are being set.
8. Teaching indicator	Lit when the teaching function is enabled and flashes when the Intelligent Signal Processor is in teaching operation.
9. RESET/TEACH Key	The maximum value and minimum value are reset by pressing this key. Teaching is available when the teaching function is enabled.
10. Up Key and Shift Key	The digit being set is scrolled by pressing the Shift Key. The set value increases by one whenever the Up Key is pressed.

Operation

■ Setting Procedures

The K3NH has four modes: RUN mode for normal operations, Setting mode for initial parameter input, Protect mode for lock-out configuration, and Maintenance mode for initializing set values and user calibration. The parameters that are accessible on any individual K3NH will vary depending on the Output Board installed. Refer to the *K3NH Operation Manual* for details.

RUN Mode:	Remains in this mode under normal operation. The process value or the max./min. value can be monitored. Using the front panel keys, the comparative set value can be changed and max./min. values reset can be performed.
Setting Mode:	Used for making initial settings. Includes settings for three menus (Set value (<i>SET</i>), setup (<i>SETUP</i>), option (<i>OPT</i>)) and the output test.
Protect Mode:	Used for locking the front key operation or parameter changes.
Maintenance Mode:	Used for initializing set values and user calibration of the inputs. The user calibration is valid for selected input ranges.

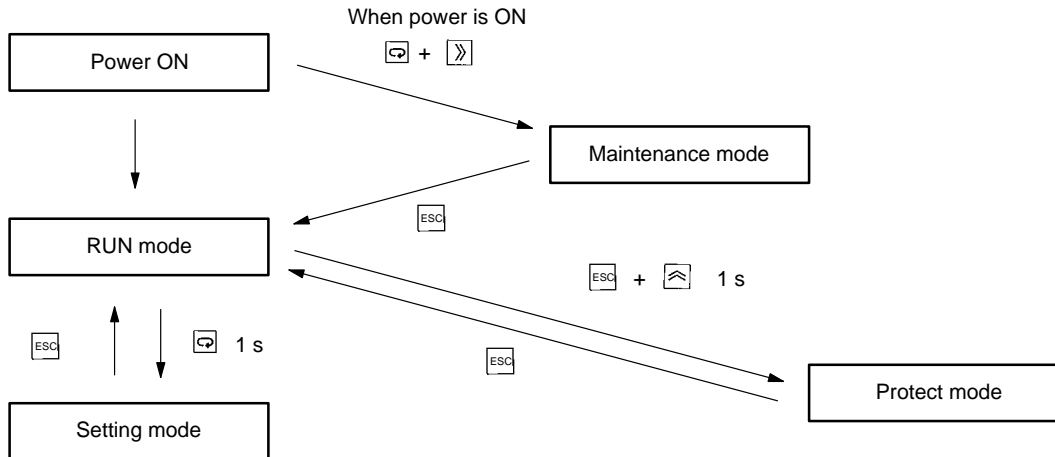

SET - Program set values

<i>SET.HH</i>	Enter set value HH
<i>SET.H</i>	Enter set value H
<i>SET.L</i>	Enter set value L
<i>SET.LL</i>	Enter set value LL

SETUP - Program input type/Serial communications

<i>INPT</i>	Determine input type
<i>UNIT</i>	Select the °C/°F display
<i>SCALE.H</i>	Scaling upper limit
<i>SCALE.L</i>	Scaling lower limit
<i>DECPT</i>	Select decimal point
<i>UNITNO</i>	Enter the unit no. for the host
<i>BPS</i>	Select the baud rate
<i>LEN</i>	Select the word bit length
<i>STOP</i>	Select the stop bits
<i>PRTY</i>	Select the parity bits

OPT - Supplementary settings related to display or control

<i>AUG</i>	Set for averaging process value
<i>DIGIT</i>	Select the number of digits to be displayed
<i>SHIFT.H</i>	Select shift amounts of input shift upper limit values
<i>SHIFT.L</i>	Select shift amounts of input shift lower limit values
<i>HYS</i>	Enter hysteresis value
<i>OUTPUT</i>	Select the output pattern
<i>STDBY</i>	Enable standby sequence
<i>SET.H</i>	Enter the upper limit (H) of linear output range
<i>SET.L</i>	Enter the lower limit (L) of linear output range
<i>RL</i>	Select the remote/local programming

TEST - Generating simulated input for testing the output function

PROT - Program lock-out configuration

<i>ALL</i>	Enable all key protection
<i>SET</i>	Enable set value change prohibition
<i>MAXMIN</i>	Enable prohibition of max./min. value reset using the front panel keys
<i>SECT</i>	Specify the menus to be protected against setting in the setting mode

Parameters

Scaling Upper/Lower Limit $\bar{L}_n\bar{H}/\bar{L}_n\bar{L}$

When the input type is set to the current/voltage input, input signals can be converted and displayed in the desired display value. The setting can be made by inputting display values that correspond to the upper-limit input value and lower-limit input value for the selected input type. The decimal point can be set to any position.

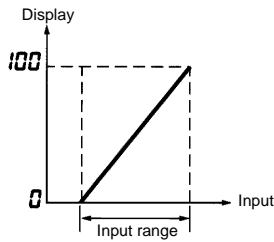

When displaying the 4- to 20-mA input as 20.0% to 95.0%.

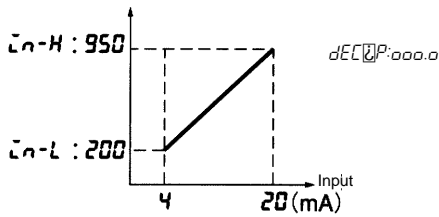

Average Processing \bar{AUG}

The average processing function stabilizes displayed values by averaging the corresponding analog input signals that fluctuate dynamically or reducing the noise in the input signals.

Input Shift $\bar{L}_n\bar{SH}/\bar{L}_n\bar{SL}$

When temperature input is selected, scaling is not required. This is because input is treated as the "temperature" as it is matched to the input type. However, note that the upper- and lower-limit values of the sensor can be shifted. For example, if both the upper- and lower-limit values are shifted by 1.2°C, the process value (before shift) is regarded as 201.2°C after shift when input is 200°C before shift.

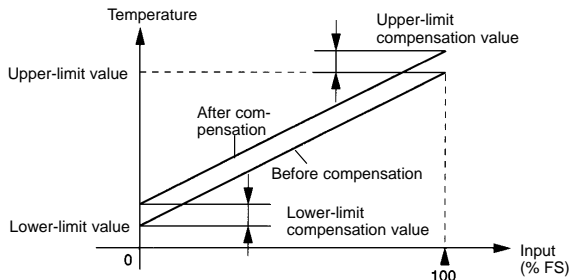

Hysteresis $\bar{HY5}$

The hysteresis of comparative outputs can be set to prevent the chattering of comparative outputs. Refer to page 12 for more details.

Output Pattern Selection \bar{OUT}

The patterns of comparative output are selectable according to the level change. Select the pattern according to the application.

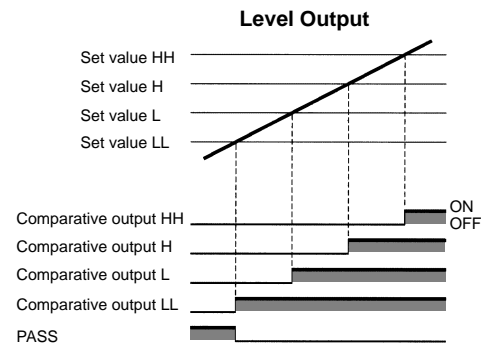
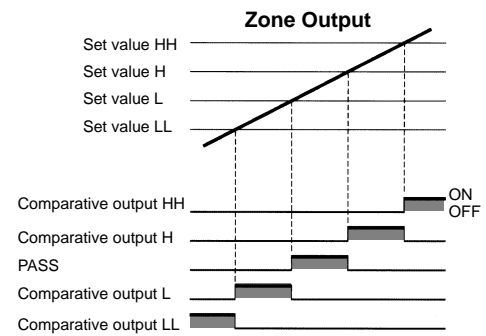
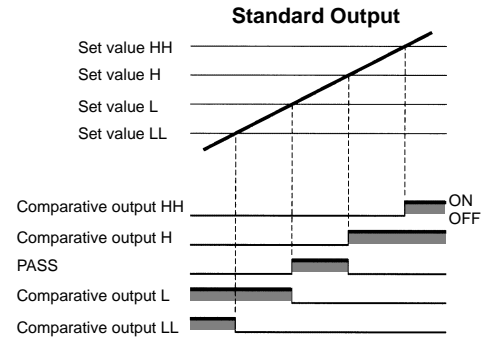

Note: The following setting conditions must be satisfied, otherwise no zone output will turn ON correctly.
 $LL < L < H < HH$

Standby Sequence \bar{StdbY}

The comparative output operation can be disabled from when the power supply is turned ON to when it enters the PASS range. This is effective for avoiding any unnecessary output until the output reaches the measurement range after the power is turned ON. (Since other comparative output operations are disabled until the output falls within the PASS range, comparative output operation may not be performed if the settings are incorrect. Therefore, be careful when selecting the comparative output pattern and setting various comparative values.)

Example: When the standby sequence function is ON.

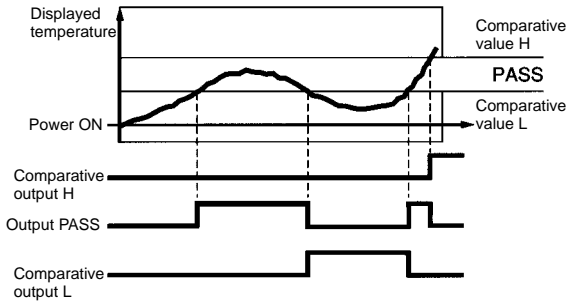

Linear Output Range *LSEL*

A linear output range can be set as required. A value corresponding to the maximum output value and that corresponding to the minimum output value can be set.

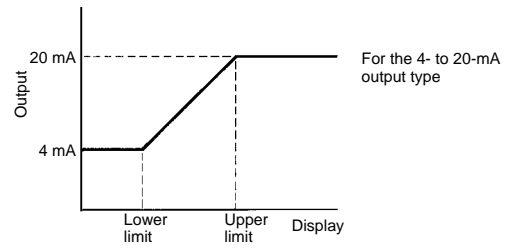

Remote/Local Selection *r₀L*

Select remote programming when performing all settings through the host devices and select local programming when performing settings through key operation.

External Connection
Terminal Arrangement

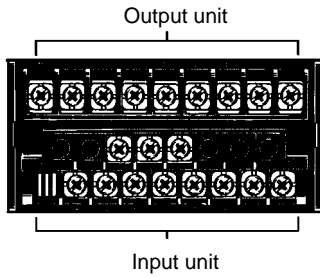

Terminal Numbers

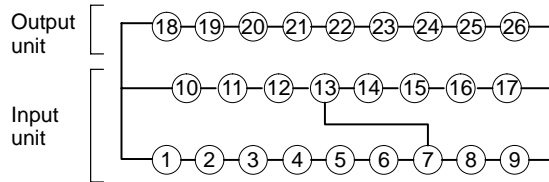

Note: Terminals 7 to 13 are connected internally.

Input Unit

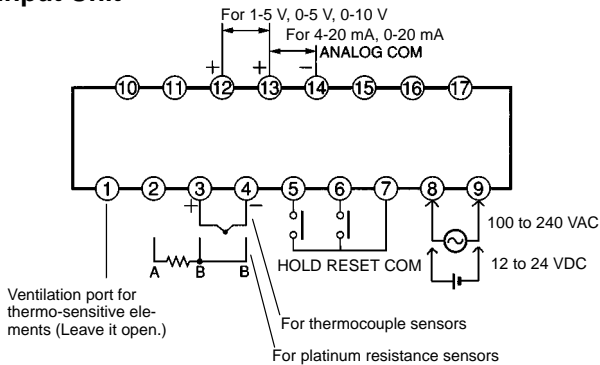

When inputting the external control signals through the open collector:

- Transistor Inputs:
- ON: Residual voltage must be 3 V max.
- OFF: Leakage current must be 1.5 mA max.
- The switching capacity must be 20 mA or greater.

When the external signal input is short-circuited, a voltage of approximately 5 V will be applied to between the terminals 5 to 7 and the COM terminal, and a current of approximately 18 mA (nominal value) will flow.

Output Units

K31-C1: Relay (3 Outputs)

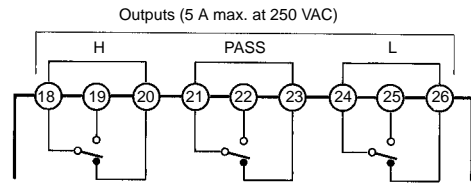

K31-C2: Relay (5 Outputs)

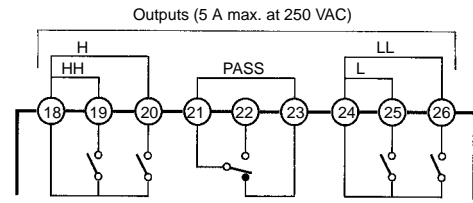

K31-C5: Relay (5 Outputs)

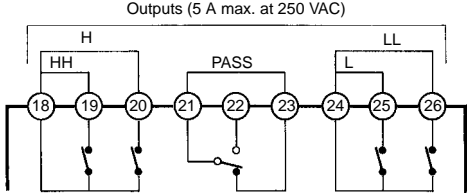

K31-T1: Transistor (NPN Open Collector)

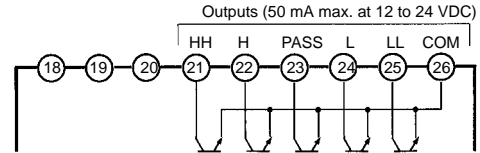

K31-T2: Transistor (PNP Open Collector)

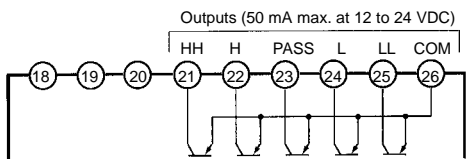

K31-B2, -B4: BCD (NPN Open Collector)
(Terminals 32 to 36 are provided only on K31-B4.)

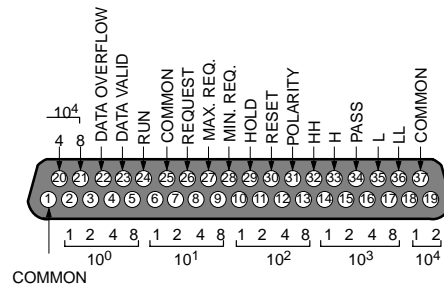

K31-L1, L2, L3, -L4, -L5, -L6, -L7, -L8, -L9, -L10: Linear

(Terminals 21 to 26 are provided only on K31-L4, -L5, -L6, -L9, -L10.)

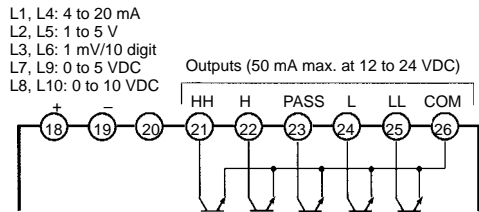

K31-FLK1: RS-232C

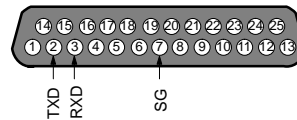

K31-FLK2, -FLK5: RS-485

(Terminals 21 to 26 are provided only on K31-FLK5.)

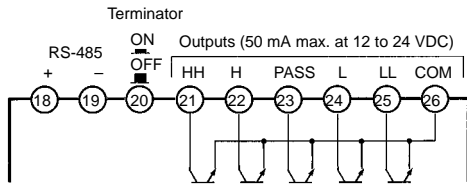

- D-sub 37P Connectors for BCD output (attachment)
Plug: XM2A-3701
Hood: XM2S-3711
- D-sub 25P connectors for RS-232C output (K31-FLK1) (order separately)
Plug: XM2A-2501
Hood: XM2S-2511
- D-sub 9P connectors for RS-422 output (K31-FLK3 and K31-FLK6) (order separately)
Plug: XM2A-0901
Hood: XM2S-0911
- D-sub 9P connectors for RS-232C output (K31-FLK4) (order separately)
Plug: XM2D-0901
Hood: XM2D-0911

K31-FLK3, -FLK6: RS-422

(The right connector is provided only on K31-FLK6)

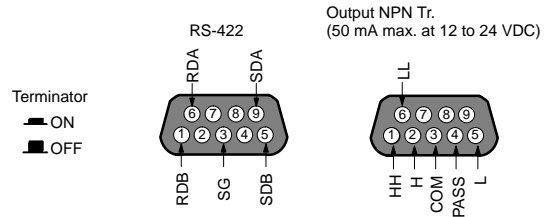

K31-FLK4: RS-232C + Transistor (NPN Open Collector)

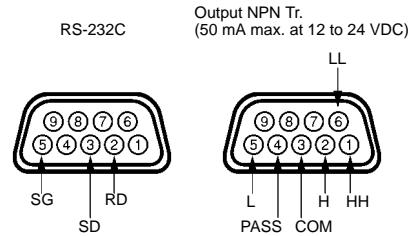

■ Output Operation Timing in RUN Mode (Relay or Transistor Outputs)

The following timing chart is for a 5-comparative Output Board when the standard output pattern is selected.

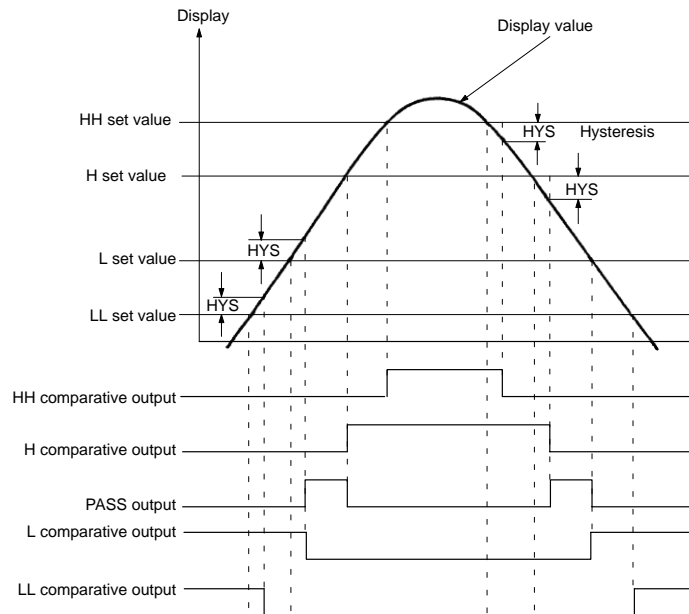

Note: The hysteresis value set in setting mode will be applied to all set values.

■ BCD Output Timing Chart

A request signal from an external device (such as a Programmable Controller) is required to read BCD data.

Single Sampling Data Output

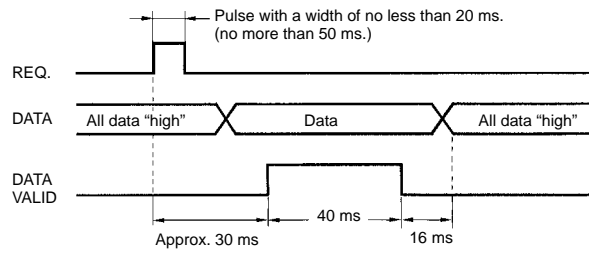

Approximately 30 ms after the REQ signal rises, a sample is taken and the DATA VALID signal is output. Read the data when the DATA VALID signal is ON.

The DATA VALID signal will turn OFF in 40 ms, and then in 16 ms, the data will go OFF.

Models with a BCD output have an open collector output configuration so that wired-OR connection is possible.

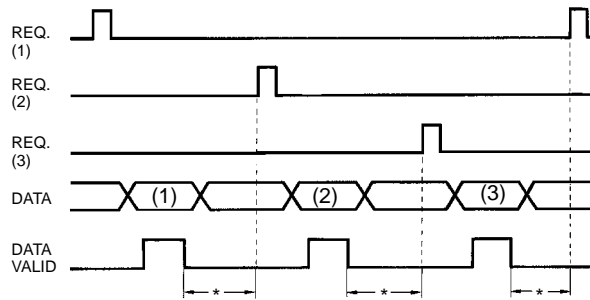
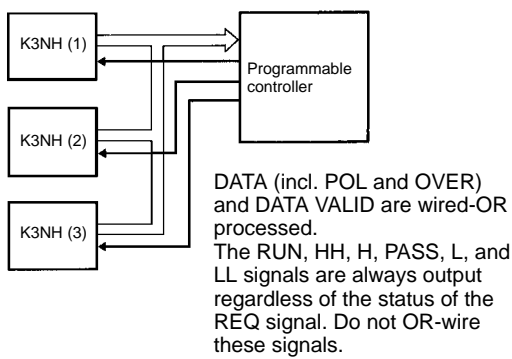

*The period between the DATA VALID signal and the REQ signal should be no less than 20 ms max.

Continuous Data Output

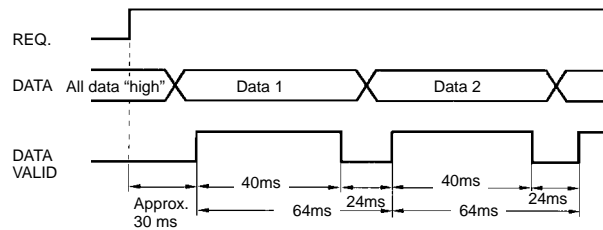

The K3NH outputs each measurement at an interval of 64 ms when a REQ signal is ON continuously.

If the HOLD signal is ON at the moment the DATA output is switched from data 1 to data 2 or vice versa, the output BCD data will be either data 1 or data 2 according to the timing of the HOLD signal. However, output data will never below.

■ Block Diagram

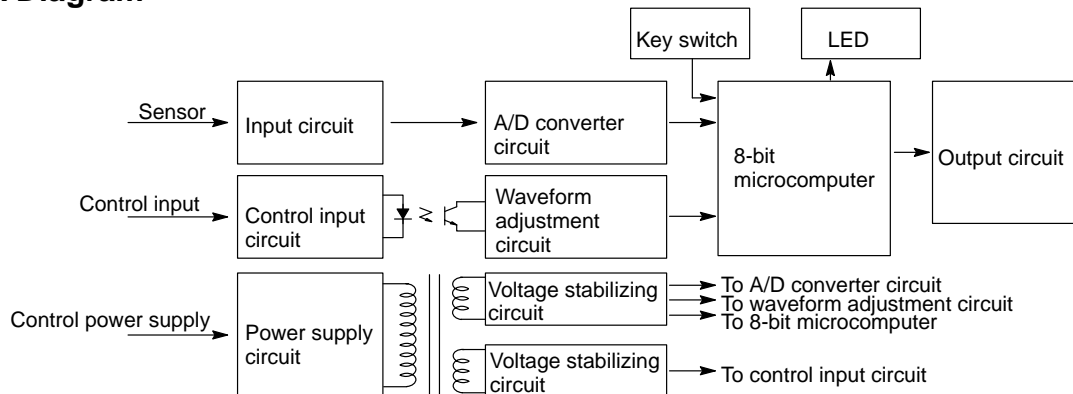

Application Examples

Inspection Lines for Gas Appliances

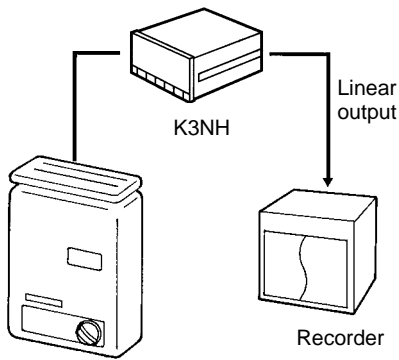

Temperature Monitoring for Plating and Coating Baths

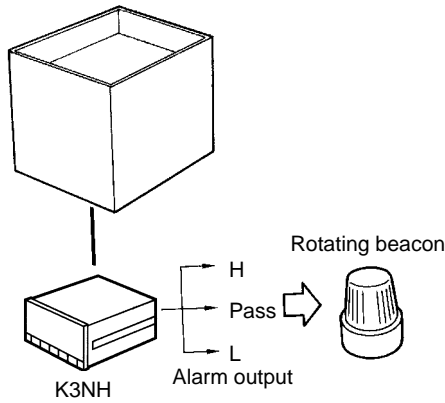

Interfacing Large External Displays

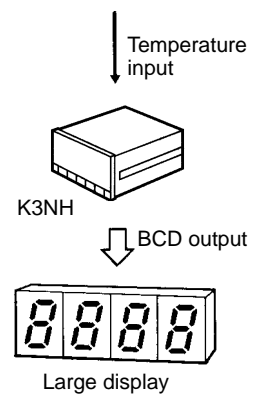

Centralized Temperature Monitoring for Industrial Furnaces

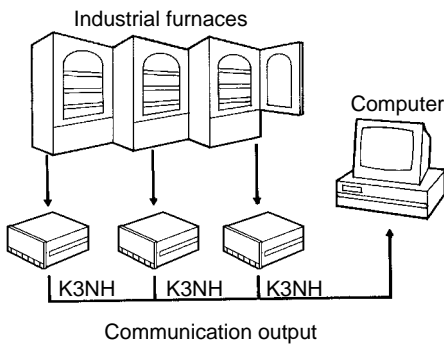

Monitoring Exhaust Temperatures on Marine Engines

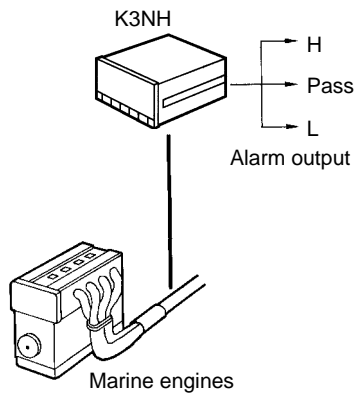

Temperature Display and Alarms for Forming Equipment

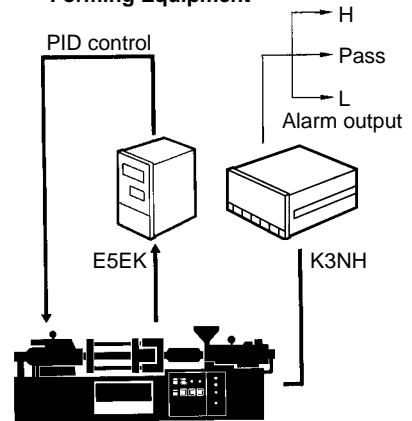

Monitoring Bearing Temperature on Generators and Motors

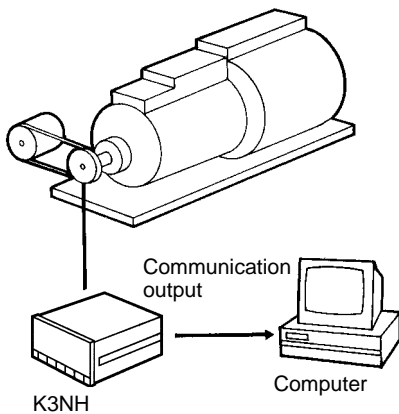

Temperature Monitoring and Control Interfaces for Multilevel Alarms

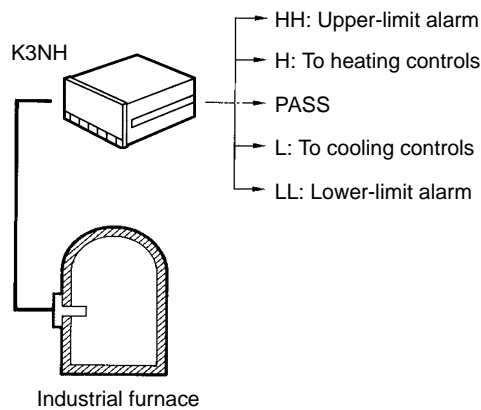

Installation

■ Example of Connection to Programmable Controller

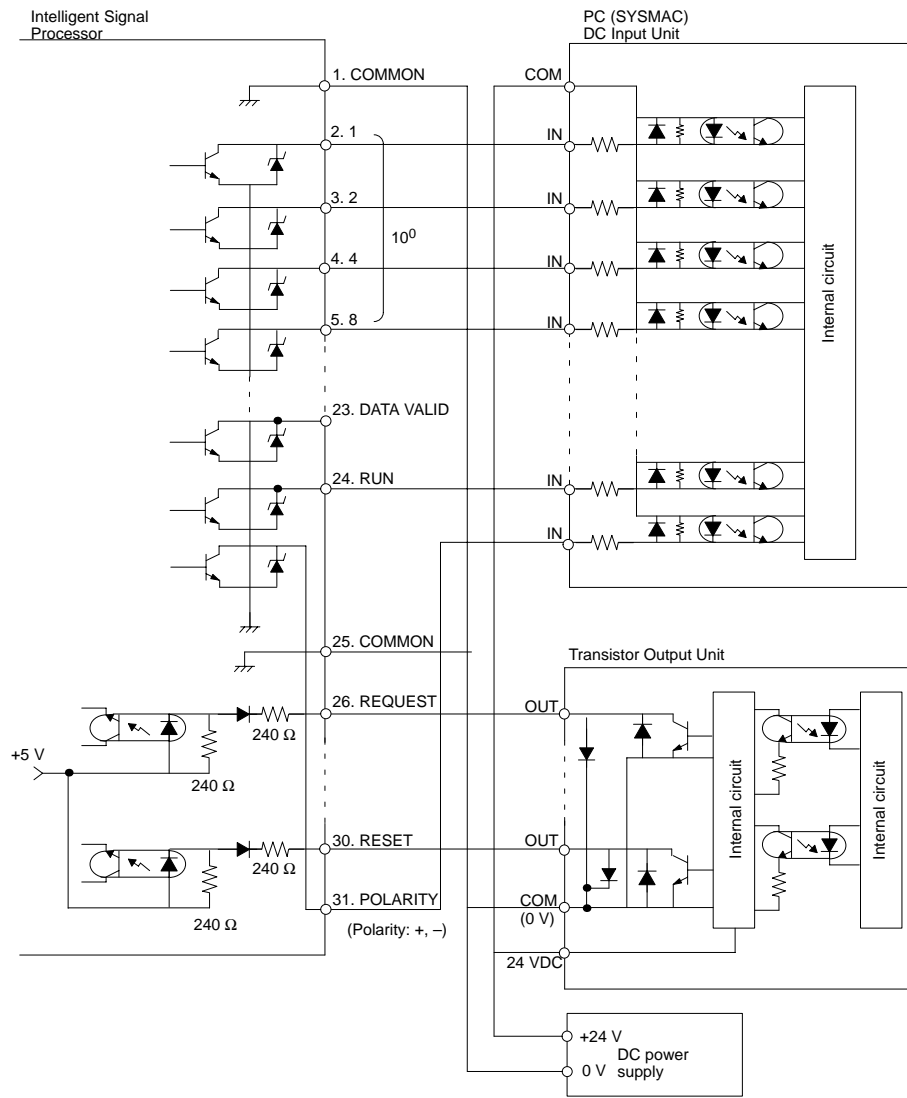

Dimensions

Note: All units are in millimeters unless otherwise indicated.

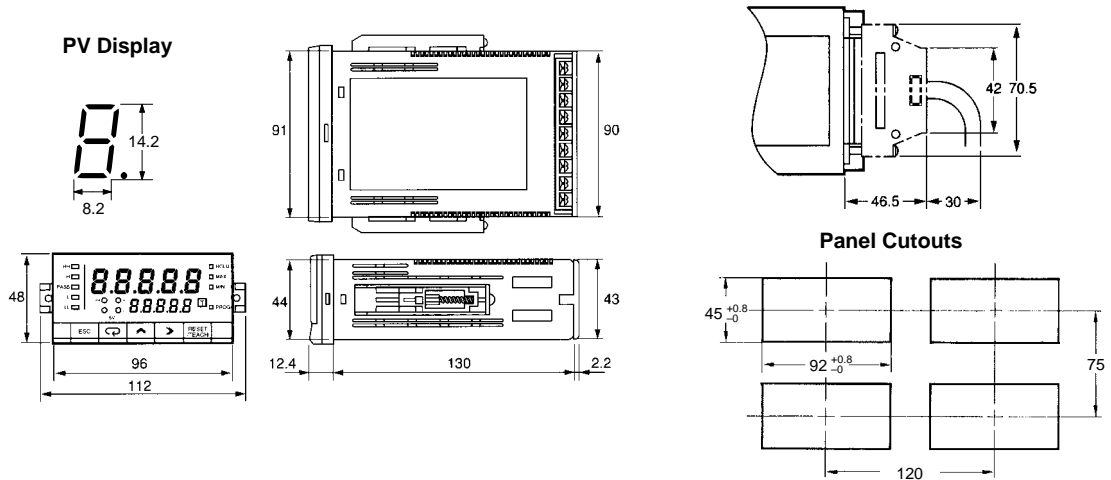

Precautions

- Be careful not to touch any terminals, otherwise you may receive an electric shock.
- Please do not disassemble the product nor touch the internal components of the product, otherwise you may receive an electric shock.
- Be sure that the power supply voltage is within the rated range.
- Do not use the Intelligent Signal Processor in locations with flammable gas or combustible substances.
- Be sure to wire the terminals correctly by checking the terminal names.
- Be sure that the terminal screws are tightened securely when wiring.

Mounting

Recommended panel thickness is 1 to 3.2 mm.

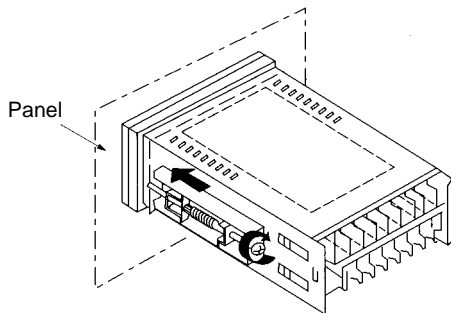

Attach the mounting bracket on the left and right sides of the Intelligent Signal Processor as shown in the illustration above and gradually tighten each screw evenly in turn by considering the balance of the tightening force until the ratchets start slipping without being further tightened.

Mount the Processor as horizontally as possible.

Never use the Processor in locations where corrosive gas (particularly sulfur or ammonia gas) is generated.

As much as possible avoid use of the Processor in a location subject to severe shock or vibration, excessive dust, or excessive moisture. Select an indoor mounting location where the Intelligent Signal Processor is at the rated temperature and humidity and free from direct sunlight.

Separate the Processor from machines generating high-frequency noise, such as high-frequency welding machines and high-frequency sewing machines.

Operation

A Processor model with a Relay Contact or Transistor Output Board may not output any alarm signal normally if the model has an error. It is recommended that an independent alarm device be connected to the model.

The parameters are factory-set so that the Processor will operate normally. The settings of the parameters may be changed according to the application.

Unit Label (Attached)

No product is shipped with the unit label attached. Select a unit label from the sheet provided and attach it to the Processor.

A	A	mA	mA	V
V	mV	mV	W	KW
VA	KVA	var	Kvar	Ω
°C	°F	K	Hz	rpm
m	mm	cm	μm	Km
l	Kl	t	TON	lx
m ³	cm ³	mm ³	Kg	g
mg	Kg/m ³	g/cm ³	m ³ /Kg	m/s ²
G	N	mmHg	mmH ₂ O	Kgf/cm ²
Kgf/mm ²	J	KJ	Kgf-cm	gf-cm
PS	hp	cal	Kcal	Kg/h
t/h	Kg/s	m ³ /min	m ³ /h	m ³ /s
l/s	l/min	l/h	m/min	mm/s
m/s	%	dB	φ-mm	SCCM
sec	ms	min	counts	×10
×100	×1000	pH	ppm	pcs
deg	cP	cSt	KΩ	MΩ
KHZ	rps			
kV	s	m ²	cm ²	rad
S	S	L	kL	L/s
L/min	L/h	kN	mN	Pa
kPa	mPa	N·m	kN·m	mN·m
kg·m ²	lx	cps	°	rph
r/s	r/min	r/h	min ⁻¹	h ⁻¹
				h.min.s
min.s. 10s			omron	

ALL DIMENSIONS SHOWN ARE IN MILLIMETERS.

To convert millimeters into inches, multiply by 0.03937. To convert grams into ounces, multiply by 0.03527.

Cat. No. N086-E1-1C In the interest of product improvement, specifications are subject to change without notice.

OMRON Corporation

Industrial Automation Company

Measuring and Supervisory Controls Department
Shiokoji Horikawa, Shimogyo-ku,
Kyoto, 600-8530 Japan
Tel: (81)75-344-7108/Fax: (81)75-344-7189

Printed in Japan
0201-0.5M (1297) (A)